

# ACCURATE

## Technology in Elevators



Lift Servicing, Installation, Upgrades & Maintenance



Welcome to  
the Future of  
**VERTICAL MOTION**

**Machine Room System (MR)**



Geared Traction Machine

**Machine Roomless System (MRL)**



Gearless Machine

**Hydraulic System (MRL)**

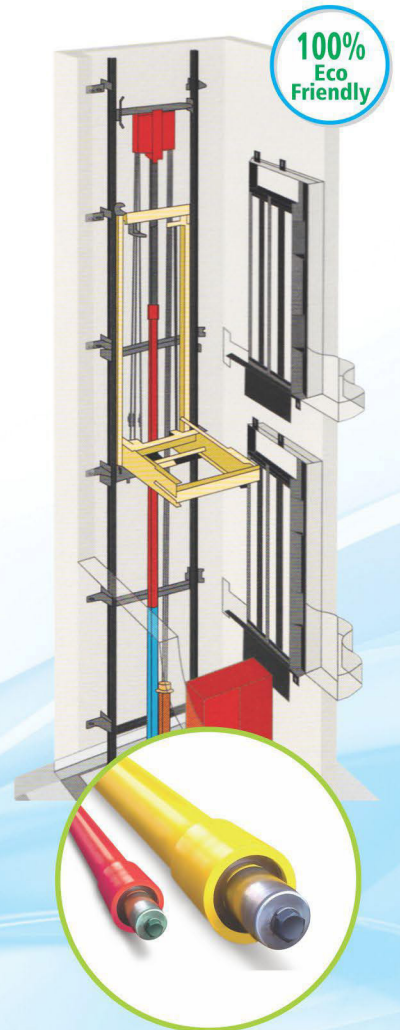

Hydraulic Cylinder

# Feature Rich Elevators

DT ALLIANZ LIFTS PVT. LTD. Passenger Elevators comes with many enviable features\*



## Door Frames :

DT Allianz Lifts come with elegant door frames in Stainless Steel or Mild Steel finishes that gives strength as well as enlarged appearance.



## Infrared Door Detector :

A full height curtain of infrared beams to prevent accidental closing of the door.



## Auto Shut off Car Light / Fan :

If there is no call for a specific period, the car lighting and ventilation Fan will automatically turn off to conserve energy.



## Regenerative Converter :

For energy conservation, power generated by a traction machine can be used by other electrical systems in the building.

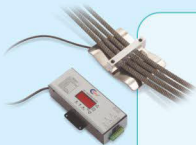

## Over Load Indicator :

In case the lift is overloaded than its rated capacity an audible / visual signal turns on.



## Supervisory Panel :

Each elevator status and operation can be remotely monitored and controlled through a panel installed in a building's supervisory room etc.



## Automatic Rescue Device (ARD) :

Automatically takes the lift to the nearest level in case of power interruption, doors open to facilitate the safe evacuation of passengers.



## VVF Controllers :

The Variable Voltage Variable Frequency (VVF) control ensures 50% energy savings. It also creates a super comfortable ride quality with jerk free starts and stops. Smooth acceleration and deceleration and no landing variations. In the long run, this prevents wear and tear of components which means less downtime and huge saving on spares.



## Stainless Steel Buttons :

Sophisticated design buttons flush with backplate having Orange / Red illumination with engraved numbers. Highly temper resistance with / without braille markings.

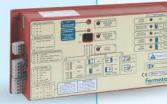

## VVF Door Controller :

Silken smooth door movement. Advanced features like adjustable independent times for opening and closing. Slow nudging feature ideal for high traffic situations.



## LCD / TFT Position Indicators :

The LCD or TFT display of Car operating panel shows the car position, travel direction and elevator status message.



## Floor Annunciator :

Recorded voice with music announces the floor number on arrival.



## Inter communication system :

A system which allows communication between passengers inside the car and the building personnel.



## Extended Door Open Button :

When the button inside the car is pressed the doors will remain open longer to allow loading and unloading of baggage, a stretcher etc.



## Fire Emergency Operation :

To enable fire service personnel to take over complete control over the elevator.



## Car Arrival Chime :

Electronic chimes sound to indicate that Car has arrived floor (for duplex only)



## Emergency Car Lighting :

Car Lighting which turns on immediately when power fails, providing a minimum level of lighting within the car.

## Cabin Designs

### Freedom of designs

Create the look and feel you like. Combine colors, materials, lighting, mirrors, handrails and fixtures to achieve the ambiance that fits both your ideas and your building.

Choose from one of our four interior design lines or design the whole car to your own taste.



**DTA-01**  
Stainless Steel & Half Glass Designer Cabin



**DTA-02**  
M.S. & Glass Designer Cabin



**DTA-03**  
Wooden & Glass Designer Cabin



**DTA-04**  
Stainless Steel & Glass Designer Cabin



**DTA-05**  
Stainless Steel & Glass Decorative Cabin



**DTA-06**  
S.S. Hairline & Glass Designer Cabin

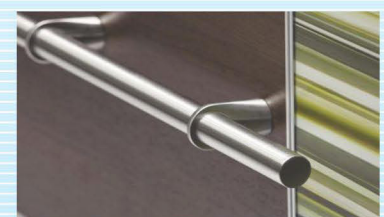

Design lines, colors and materials.  
Design that speaks to your senses.



DTA-07  
Rose Gold & Glass Designer Cabin



DTA-08  
Golden Designer Cabin



DTA-09  
Golden Designer Cabin



DTA-10  
Golden Designer Cabin



DTA-11  
S.S. Hairline & Designer Cabin



DTA-12  
Golden Designer Cabin





The Stylish Way to  
Brand Your Elevator

Automatic Door



Center Opening Auto Door (Small Vision)



Hairline Finish Telescopic Autodoor



Center Opening Plain S.S. Door

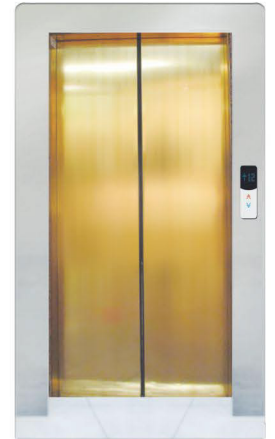

Rose Gold Center Opening Autodoor



Center Opening Auto Door (Four Panel)



Full Glass Door



Full Vision Glass Door



Half Glass Autodoor

Manual Door



Manual Imperforate Door



Manual Collapsible Door



Manual Telescopic Door

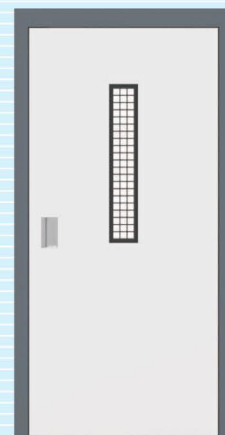

Manual Swing Door



M.S. Powder Coated Frame Full Glass Swing Door



# Capsule Elevator

## Smooth Operation Comfortable Travel

Our premium capsule elevators fast and highly cost-effective way to create a full-glass elevator solution for your building.

There are multiple car models to choose from, as well as a wide range of interior design options and other customization possibilities.

Available Rated Speed : **1.0 / 1.5 / 2 MPS**  
 Max Travel Height : **66 M**  
 Available Rated Capacity : **408 to 1088 Kgs**  
 Max Passengers : **06 to 16 Passengers**



Square Glass Cabin



Five Side Glass Cabin



S.S. Round Glass Cabin



Powder Coted Round Glass Cabin

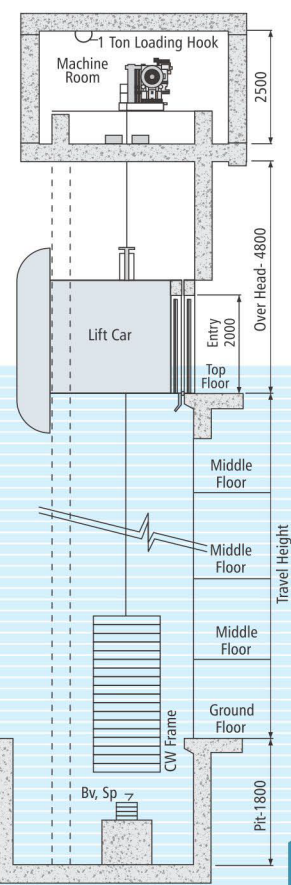
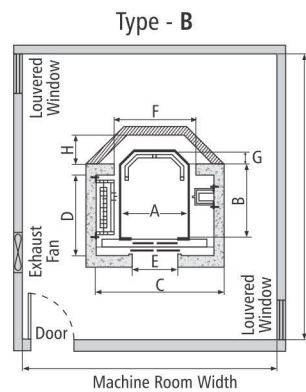
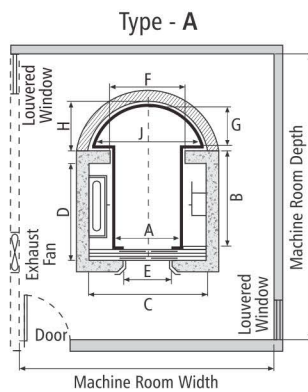

Type - A

Person	Load Kgs.	Car Inside				Left Well				Entrance
		A	B	J	G	C	D	F	H	
8	544	1000	1200	1250	600	2000	1225	1230	1000	800
10	680	1100	1300	1400	650	2200	1325	1330	1100	900
13	884	1200	1400	1550	700	2400	1425	1430	1100	1000
16	1068	1300	1500	1700	750	2800	1525	1530	1200	1200

Type - B

Person	Load Kgs.	Car Inside			Left Well				Entrance
		A	B	G	C	D	F	H	
6	408	1000	1100	200	1800	1250	1230	470	700
8	544	1150	1200	200	2000	1380	1350	520	800
10	680	1250	1300	250	2200	1450	1480	580	900
13	884	1400	1400	300	2400	1550	1630	650	1000
16	1068	1550	1500	350	2800	1780	1650	790	1200



Manual Door



## Passenger Elevator

### Manual Door

Manual door elevators are durable by design and accurate by technology. We have a wide range of these elevators which are most reliable and designed to suit every construction requirement and provide best vertical transportation solutions, with trouble free performance and low maintenance cost.

These elevators are a perfect blend of Cost friendly and robust performance elevator applications. They have an excellent record of customer satisfaction.

Available Rated Speed      **0.63 / 1.0, / 1.5 / 2 MPS**  
 Max Travel Height          **66 M**  
 Available Rated Capacity    **272 to 1360 Kgs**  
 Max Passengers              **04 to 20 Passengers**



Safe



Robust



Lots of Options for  
Interior and Fixtures

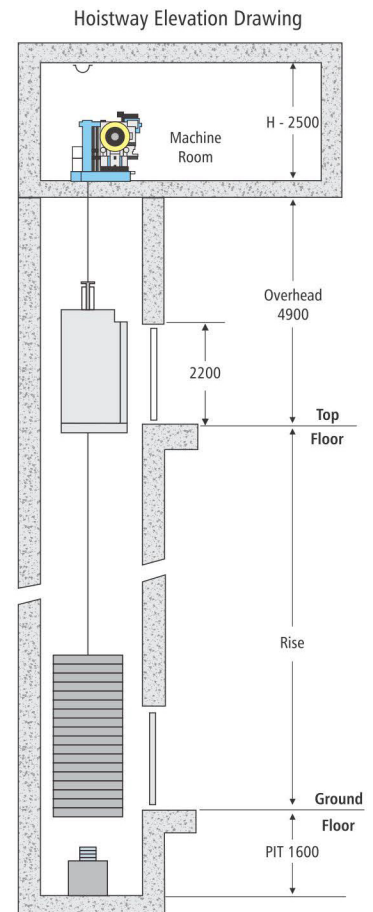
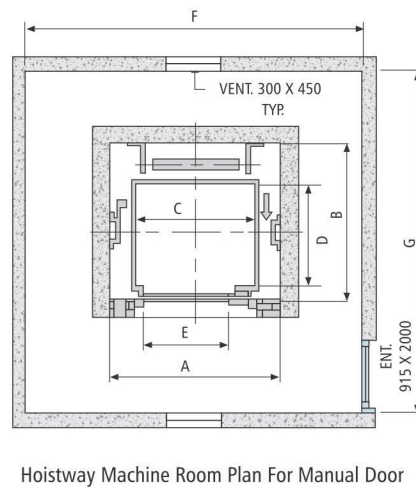
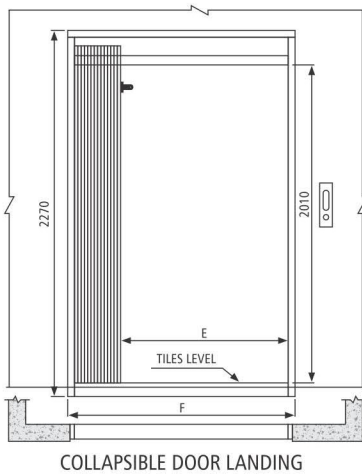

Load		Lift Well		Car Inside		Entrance	Machine Room		
Person	Weight	Width	Depth	Width	Depth		Width	Depth	Height
In Kg.		A	B	C	D	E	F	G	H
4	272	1600	1250	1100	700	700	3000	3000	2500
5	340	1600	1300	1100	850	750	3000	3200	2500
6	408	1670	1370	1100	1000	750	3000	3500	2500
8	544	1800	1600	1300	1100	750	3200	3500	2500
10	680	1850	1800	1350	1300	1000	3500	4000	2500
13	884	2500	1600	2000	1100	1000	4000	4200	2500
16	1088	2500	1800	2000	1300	1000	4500	4800	2500
20	1360	2500	2050	2000	1550	1000	5000	5000	2500



Auto Door



## Passenger Elevator

### Auto Door

Automatic doors at grocery stores and office buildings mainly exist for convenience. The automatic doors in an elevator, on the other hand, are absolutely essential – they keep people from falling down an open shaft.

Elevators use two different sets of doors: doors on the cars and doors opening into the elevator shaft. The doors on the cars are operated by an electric motor, which in turn is operated by the elevator computer.

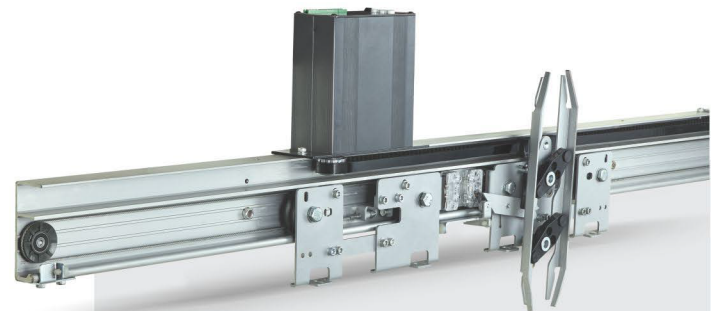

#### Top grade door machine system

Fully computerized VVVF closed-loop control mode fulfills the smooth operation. It needs no position switch. Internal self-tuning function records various floor door widths by memory. It ensures the accurate and proper door-opening.

- Available Rated Speed      **0.63 / 1.0, / 1.5 / 2 MPS**
- Max Travel Height            **66 M**
- Available Rated Capacity    **272 to 1360 kgs.**
- Max Person                    **04 to 20 Passengers**

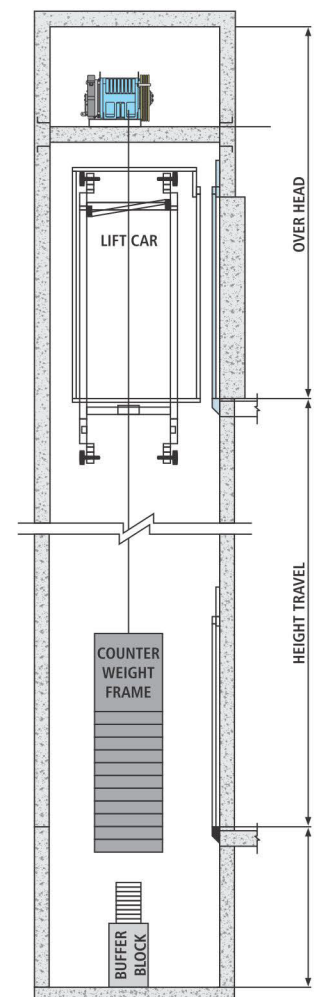
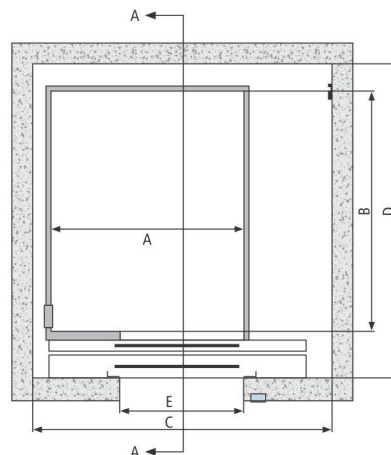
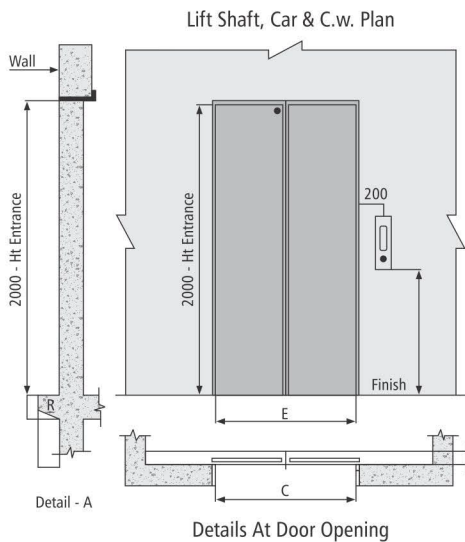

Load		Car Inside			Lift Well		Entrance		Pit	Overhead
Person	Kgs	Width	Depth	Height	Width	Depth	Width	Height	Depth	Height
6	408	1100	1000	2150	1850	1400	700	2000	1600	4800
8	544	1100	1300	2300	1950	1700	800	2000	1600	4800
10	680	1300	1350	2300	2050	1750	800	2000	1600	4800
13	884	1300	1700	2300	2100	2100	900	2000	1600	4800
16	1088	1500	1750	2300	2350	2150	1000	2000	1600	4800
20	1360	1500	2000	2300	2350	2400	1000	2000	1600	4800

Above dimension are default / indicative



Hospital Elevator



## Hospital Elevator

### Can Save Time for Quick Rescue

- The Hospital Elevator is designed Especially for Patient Vertical Transportation in Hospital.
- In Elevator Cabin Wheelchair & Stretcher Can be Accommodated.
- No Jerk is experienced at the Starting & Stopping of Elevator.
- Size of Elevator Cabin & Doors can be Adjustable as Availability of Hoistway.
- Elevator Car with two Opposite Side Opening is Possible, if required.
- Cabin is washable with Wet Cloth.

Available Rated Speed **0.63 / 1 MPS**  
 Max Travel Height **66 M**  
 Available Rated Capacity **544 to 1768 Kgs**  
 Max Passengers **08 to 26 Passengers**



Intellectual Control



Noise Reducing



Smooth and Comfortable

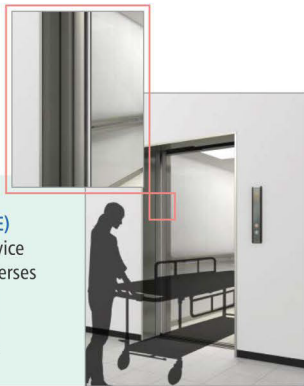

**Safety Door Edge (SDE)**  
 A mechanical safety device with a micro-switch reverses closing doors if there is physical contact with a passenger or an object.

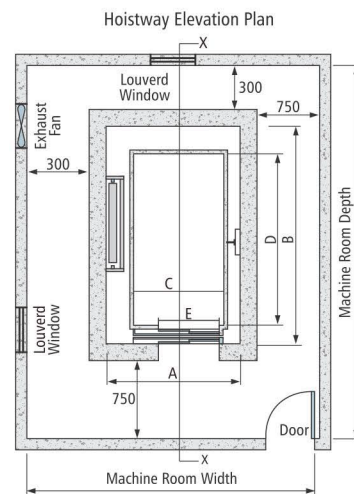

Hoistway Elevation Drawing

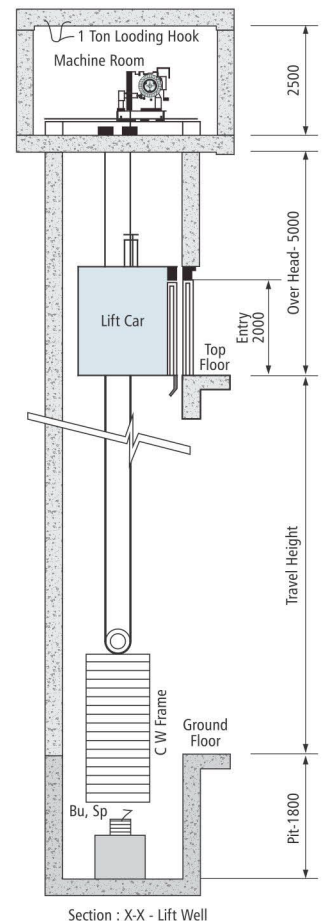

Automatic Centre Opening Door

Capacity		Shaft W	Shaft D	Car W	Car D	Shaft W	Shaft D	Car W	Car D	Entrance
Person	KG.	A	B	C	D	A	B	C	D	E
10	680	1900	3000	1000	2400	1700	3000	1000	2400	700
15	1020	1900	3000	1000	2400	1700	3000	1000	2400	800
20	1360	2300	3000	1300	2400	1950	3000	1300	2400	900
26	1768	2600	3000	1600	2400	2100	3000	1600	2400	1000

Collapsible Door Can Be Provided If Required.

Automatic Telescopic Door



Goods Elevator



## Goods Elevator

Save Valuable Time as Well As Energy

**Special Features:**

- Goods Lifts are amalgamation of Cranes and lift technology.
- Mechanisms Mounted on Fabricated Frame
- All Door entries fitted with collapsible doors.
- Cabin height not less than 2100mm.
- Cabin floors are covered with chequer plate.
- If one rope fails another rope holds the cabin from falling.
- If any gate is opened Goods Lift Will not operate.
- All floor doors are fitted With limit switches.

Available Rated Speed    **0.50 / 1.00 / 1.50 MPS**  
 Max Travel Height        **66 M**  
 Available Rated Capacity   **500 to 3000 Kgs**



Aluminum Checker Plate



M.S. Checker Plate

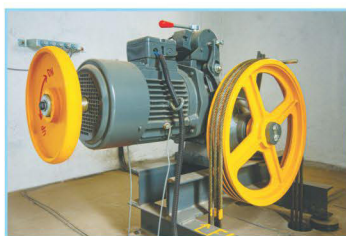

Heavy Duty Traction Machine



Accurate Leveling

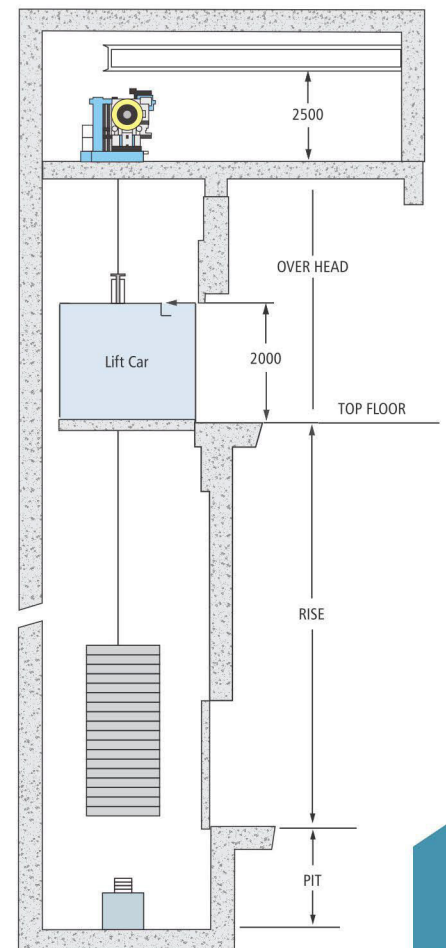
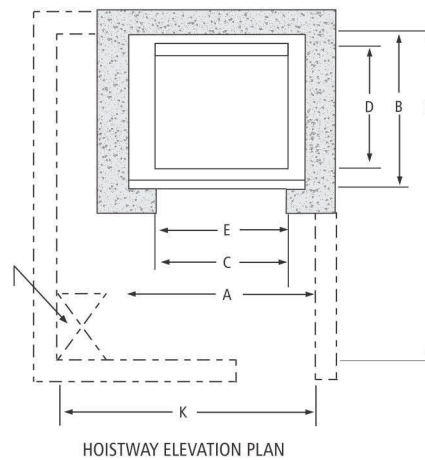

Load	Lift Well		Car Inside		Entrance		Machine Room		UPTO 0.7 M / SEC.	
Weight	Width		Depth	Width	Depth	Width	Depth	Height	Pit	O.H.
IN KG	A	B	C	D	E	F	G	H	K	M
500	1900	1500	1100	1200	750	3000	3800	2500	1600	4800
1000	2300	2100	1400	1800	1000	3000	4000	2500	1600	4800
1500	2600	2300	1700	2000	1250	3200	4200	2500	1600	4800
2000	2600	2800	1700	2500	1500	3200	4200	2500	1600	4800
2500	2900	2800	2000	2500	1500	3500	4400	2500	1600	4800
3000	2900	3300	2000	3000	2000	3500	4500	2500	1600	4800
4000	3400	3300	2500	3000	2000	4000	4600	2500	1600	4800
5000	3400	3900	2500	3600	2500	4500	4500	2500	1600	4800

All Dimension are in mm. This is General Data, without notice.



MRL Elevator



## MRL Elevator

### Machine Roomless Elevator

Less Space Less Energy More Flexibility

Brings you a revolutionary concept in the field of elevators to give you absolute freedom in designing-MRL-Machine Room Less Elevators. Our exclusive Machine room less elevators brings aesthetic enhancements for your structure.

Reduction in Elevator Equipment Area of **35%**

Available Rated Speed      **1.00 / 1.50 / 2 MPS**  
 Max Travel Height            **66 M**  
 Available Rated Capacity    **340 to 1768 Kgs**  
 Max Passengers                **05 to 26 Person**

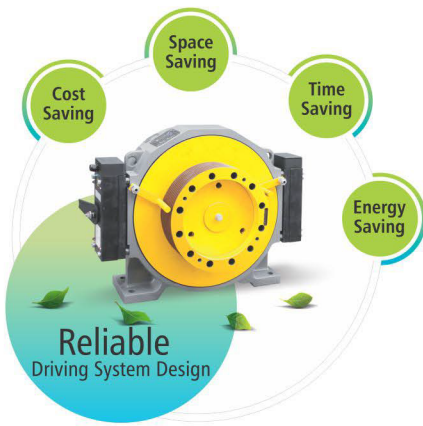

New generation permanent magnet synchronous gearless traction machine

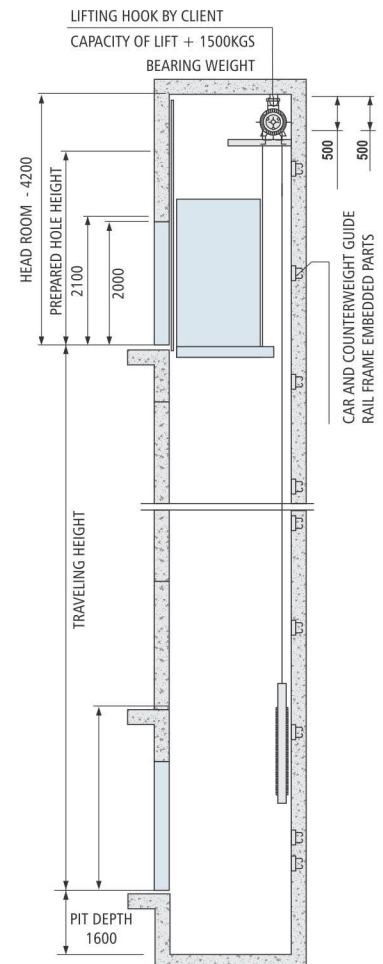
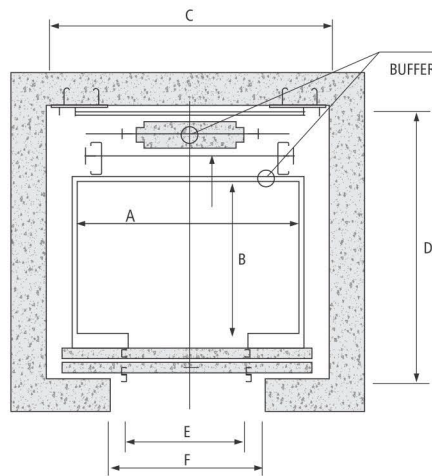

Construction Parameters

Capacity		Car Inside			Lift Well		Clear Entrance	Clear Opening At Landing
Person	KGS	A	B	C	D	E	F	F
							Auto Door	Manual Telescopic
6	408	1200	900	1800	1400	700	780 / 2100	1450 / 2350
8	544	1300	1100	1900	1600	800	880 / 2100	1600 / 2350
10	680	1300	1300	1900	1800	800	880 / 2100	1600 / 2350
13	884	1600	1400	2200	1900	900	980 / 2100	1700 / 2350

- Above dimension may vary as per different types of and equipments.
- All dimensions are in mm.



100% Eco Friendly

Home Elevator



## Home Elevator

### Luxury and Convenience in Your Home

Home Elevator is designed to meet vertical transportation needs in private bungalows. It is the ideal solution for elderly and impaired persons who can finally move autonomously and free from stairs.

It is a modern product, designed and manufactured to meet a wide range of needs from the garage to the roof, you can move effortlessly up to 4 floors.

Available Rated Speed **0.30 / 0.63 MPS**  
 Max Travel Height **12 M**  
 Available Rated Capacity **300 to 450 Kgs**  
 Max Passengers **4 to 6 Passengers**

#### Main feature and benefits :

- Runs with single phase power supply.
- Required very compact overhead space and pit area.
- Saves up 40% energy compared to hydraulic elevator.
- Noiseless and vibration free.
- Easy to install and maintain.

Mini Gearless Machine



Save Energy



Low Noise



Comfortable

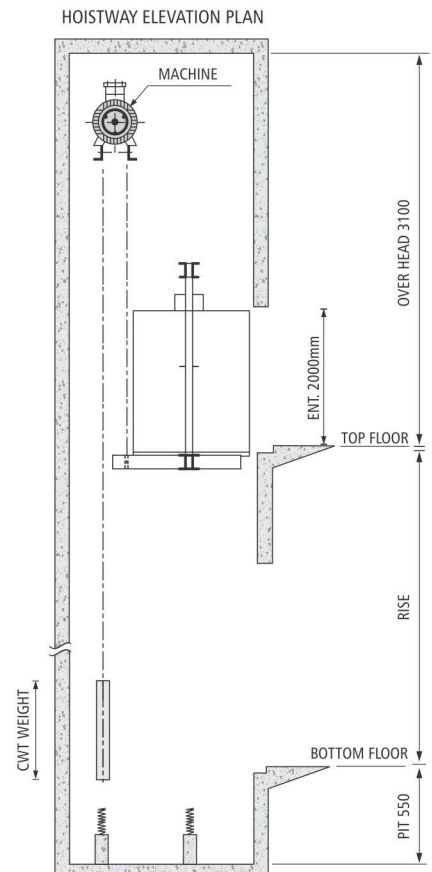
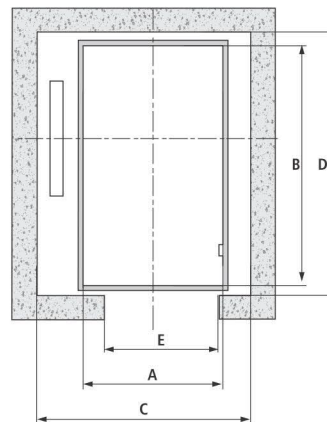

Door Operation	Load		Lift Well		Car Inside		Entrance	Speed (MPS)	Pit	Over Head
	Persons	KGS	C	D	A	B				
Manual Door	3	204	1100	1200	810	700	700	0.3	550	3100
Manual Door	4	272	1300	1400	800	1200	700	0.3	550	3100
Auto Door	3	204	1250	1250	810	700	700	0.3	550	3100
Auto Door	4	272	1300	1600	850	1150	700	0.3	550	3100

Note : This Is Our Standard Data, If other Special Requirement Please Contact us.



Car Elevator



## Car Elevator

### The Most Reliable Parking Assistants

Car elevators help to alleviate the problems of finding sufficient parking space in busy areas, and save on costly land in commercial space.

These lifts smoothly transport vehicles to the tops of building, or to basements and showrooms.

They are carefully engineered for independent access of vehicles in private homes or multi-family residences where space is valuable.

Available Rated Speed **0.30 / 0.50 MPS**  
 Max Travel Height **30 M**  
 Available Rated Capacity **2500 to 4000 Kgs**



Bi-Partical Door

Description	Vertical Transportation for Cars/ LMVs
Segment	Industrial applications & Car Parks
Max. travel (m)	100 (Solutions available for higher travel)
Max. load (kg)	500 - 5000 Kg (Solutions available for higher capacities)
Max. speed (m/s)	0.5 mps (Solutions available for other speeds)

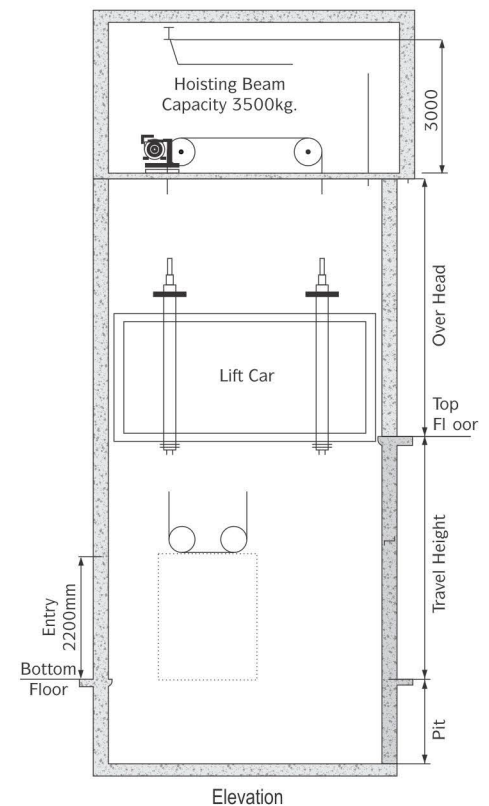
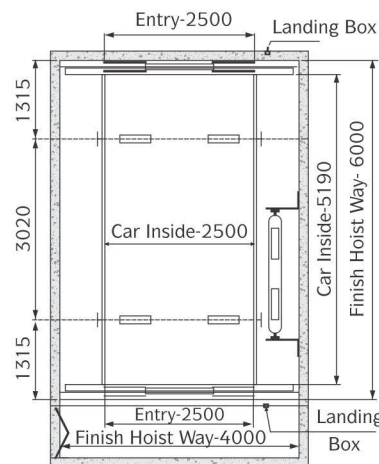

## Different Type Car Parking Lift

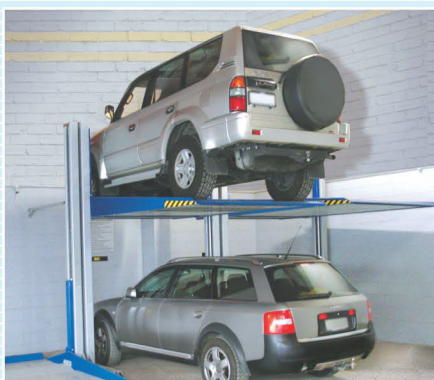

Two Car Parking System



Car Puzzle Parking



Electric Scissor Car Lift



Hydraulic Elevator



## Hydraulic Elevator

For Low Rise

Looking for a low-maintenance elevator Hydraulic elevator provide the advantages of being relatively inexpensive, safe and easy to maintain. They're very convenient and cost-effective solution for low-rise buildings with low traffic.

Hydraulic elevators have been rated the safest option for home elevators. They boast superb user friendliness and easy access machine room located at the basement. Once they are put in place, hydraulic elevators provide the smoothest rides possible.

Available Rated Speed	<b>0.30 MPS</b>
Max Travel Height	<b>30 M</b>
Available Rated Capacity	<b>204 to 408 Kgs</b>
Max Passengers	<b>3 to 6 Passengers</b>



HOLE TYPE ACTING

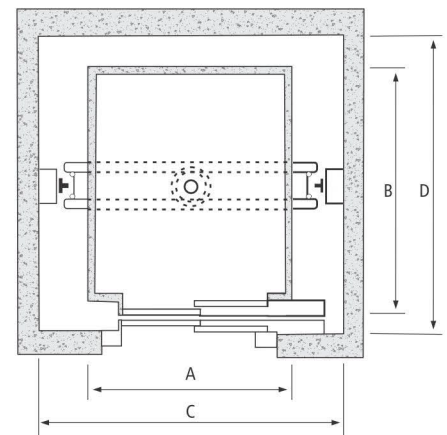

It is a directly acting suspension with a simple or split piston.  
It is the simplest solution of suspension for any load.

Persons	Capacity Kg	Car-W (A)	Car-D (B)	Shaft-W (C)	Shaft-D (D)
3	225	800	1100	1500	1500
4	300	850	1050	1550	1550
5	375	1000	1200	1600	1600
6	450	1100	1250	1700	1700
8	600	1200	1500	1700	1800
10	750	1200	1700	1700	2000
12	900	1300	1800	1900	2100
15	1125	1300	2200	2000	2500
20	1500	1400	2500	2100	2800
24	1800	1500	2500	2200	2800



Service Goods Lift

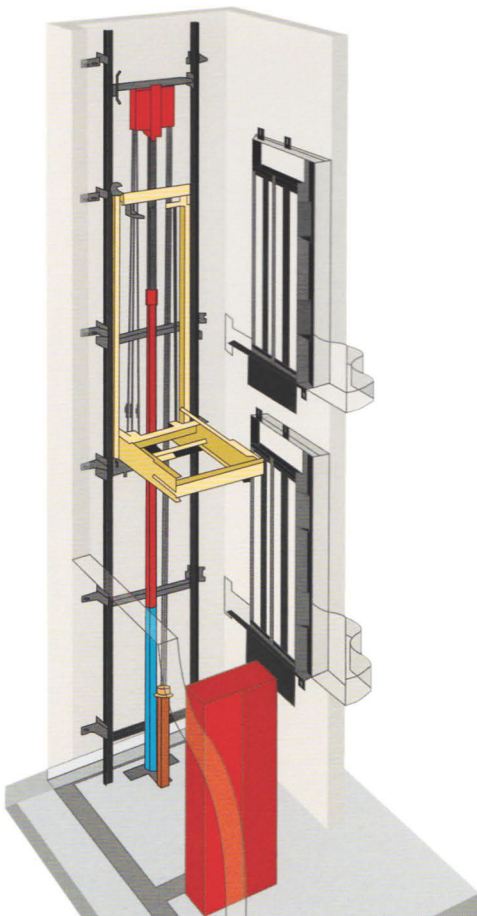



### COP & LOP

Car Operating Panel & Landing Operating Panel



EL 03 COP - LOP



SM : GRAND COP-LOP



A wide variety of operating panels for lifts with great flexibility in special construction.



ET-02C



ET-02L



SM : I TOUCH White COP-LOP



Vertical Display Effect



Horizontal Display Effect

### Display of Calling Box



TFT Color Display



Monochrome

### Push Button



SM : Classic COP-LOP



SM : I TOUCH Black COP-LOP



## Green Installment Saving Environment Friendly

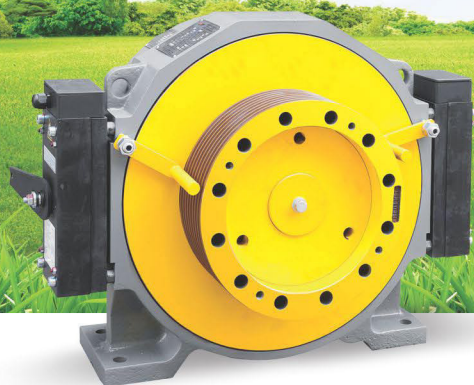

Gearless Traction Machine



Save Energy



Low Noise



Comfortable



MGI-127L  
Gearless Machine



MRL Gearless Machine



Mini Gearless Machine

## Lift Duty Reduction Geared Machine Units



Montanari Heavy Duty  
Traction Geared Machine

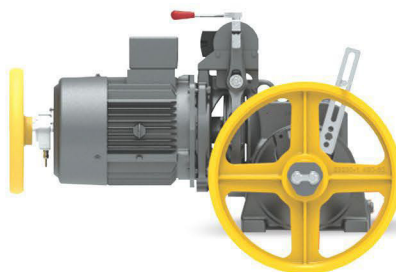

M67  
Geared Traction Machine



CAULDRON - 135N  
Geared Traction Machine

## Controller

The safe and More Energy-Saving Integrated control



Traction MR Geared Controller

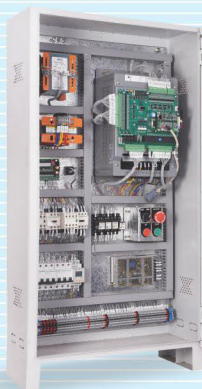

STEP®  
Elevator Parallel  
Integrated Controller

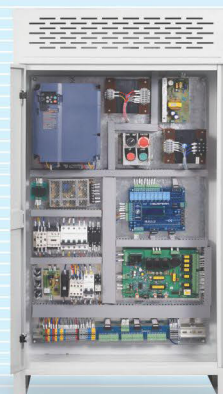

HEDEFSAN®  
CONTROLLER with ARD



STEP®  
Elevator Serial  
Integrated Controller



# ACCURATE

We Pioneered NICE Integrated Solutions for Elevators

**>2,000,000** Installations Worldwide





## Escalator

### S310-35K COMMERCIAL ESCALATOR

- ▶ Escalator suitable for hotels, office buildings, super markets, and airports.
- ▶ The step width can be 600mm, 800mm and 1000mm.
- ▶ The inclination can be 30° & 35°.
- ▶ The alternative function includes VVVF, auto-lubrication & error analysis.
- ▶ The requirements can be customized.

#### Functions

- ▶ Automatic inspection status transformation
- ▶ Handrail entrance device
- ▶ Up and down start key
- ▶ Emergency button/operation brake control
- ▶ Broken step chain safety device
- ▶ Comb safety device/ Protection from over speed
- ▶ Non-reversing safety device
- ▶ Inspection device
- ▶ Overload protection
- ▶ Control device for handrail breakage
- ▶ Phase monitoring relay
- ▶ Auxiliary brake [H>6.0m]

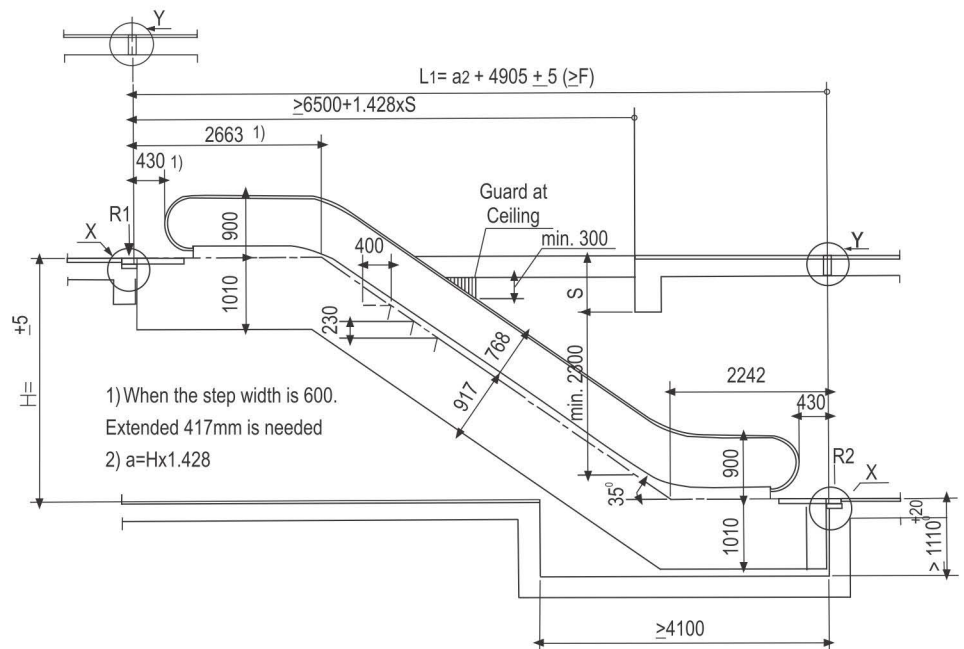
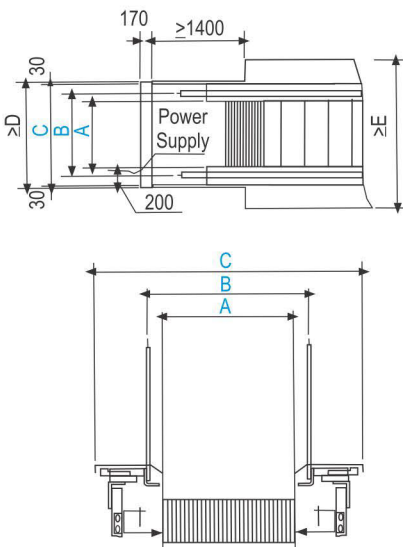

Superb performance comes from stringent design



Smooth Operation



Long Service Life



Quiet Running -Quiet Drive Units

	S310-35K60	S310-35K80	S310-35K100
A	600	800	1000
B	838	1038	1238
C	1200	1400	1600
D	1260	1460	1660
E	1838	2038	2238
F	18500	16900	15700

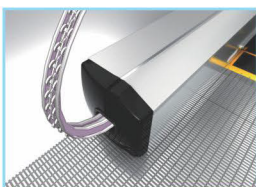



## Our Accelerator Service

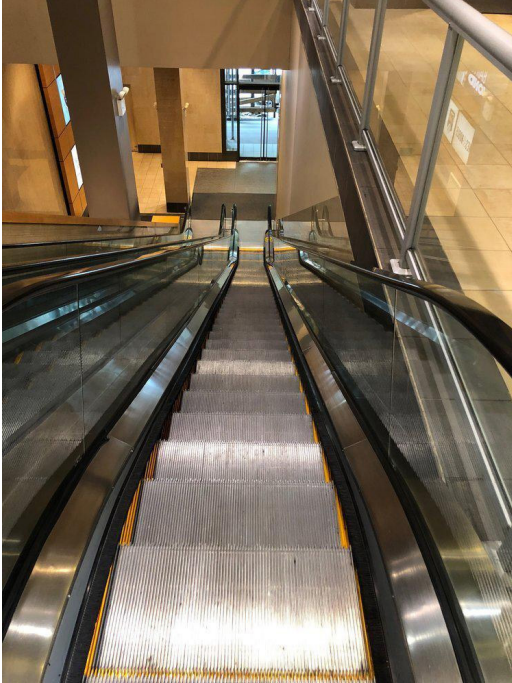

# Safety is everything.

When passengers ride our elevators  
we want them safe.

The logo for ACCURATE, featuring the word in a stylized, orange, sans-serif font with a blue outline, set against a black circular background.

## New Installation

Installation works are carried out after discussions on the type of lifts required to meet the demands of the buildings, using the latest technology and equipment.

## Maintenance Contract

We are one of the reliable and well know service providers for elevators maintenance. We offer our clients' annual maintenance contract for all types of lifts.

## Modification

We modify our clients elevator with the latest and updated techniques, technology, design and compact features to ensure maximum safety and to reduce the energy cost.

## Repair & Service

We possess dynamic professionals to provide repairing and other maintenance service at market price for better functioning of the elevators and its inner devices.



We are Technically Associated with



Contact no. : +91 7988880828

Mail : [accurateelevator8@gmail.com](mailto:accurateelevator8@gmail.com)

Address : DSS 34, Sec-5 Rohtak 124001,  
Haryana